

Article number: 6160402012

Description: Welding hub for taper bush type MSB
for taper bush 2012

Measures

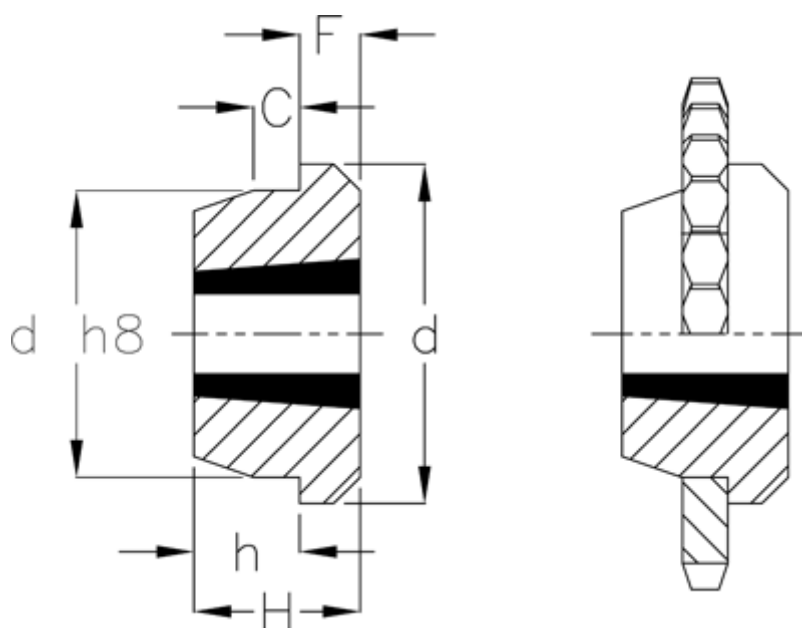

C	= 12
d	= 96
d H8	= 90
F	= 10
For taper bush = 2012	
H	= 32
h	= 22